

HIGH VOLTAGE (HV) OUTDOOR TERMINATION OHVT-245C (2A)

UP TO 245 kV

KEY FEATURES

- Pressure-tight and light weight composite housing
- Prefabricated and factory tested silicone rubber stress cone
- No special tools required to install the termination
- Silicone oil filling without preheating
- Isolated base plate for sectionalization
- Fittings made of corrosion-resistant alloy
- Type tested according to IEC 60840 and IEC 62067 standards

TE Connectivity's (TE) Raychem High Voltage Outdoor Termination series (OHVT) is designed for voltages up to 245 kV and can operate under severe environmental conditions. The OHVT is designed such that it is compatible with polymeric insulated cables independent of the manufacturer and can be adapted with respect to grounding required for various cable constructions.

Composite housing with different creepage lengths are available and covers all pollution levels, from common to the most extreme. The installation of the termination can be done by a trained installer equipped with conventional tools. The termination is designed and tested according to the following standards: IEC-60840, IEC-62067, IEC-60815, IEEE-48.

The pressure-tight composite housing is made of a glass fiber reinforced (GFR) resin tube with silicone rubber sheds molded to the tube. The metal fitting associated with the termination consists of a corrosion-free alloy. The cable lug is available both in crimp and shear-off bolt version. It is suitable for all common conductors made of aluminum or copper. The insulator fills from the top with silicone oil, which does not require prior heating. The flexible double sealing system at the lug is installer-friendly and ensures protection against environmental influences. A heat-shrinkable polymeric tube containing oil-resistant sealant encapsulates the connector barrel and the polymeric insulation transition.

Customers can count on consistent, high quality products, driven by TE's proven innovation and backed by our extraordinary customer support.

HV Outdoor Terminations OHVT-245C (2A)



MECHANICAL DATA	
Length without connection bolt	2564 mm
Outer diameter of insulator	402 mm
Inner diameter of insulator	300 mm
Cantilever force	5000 N
Max. permissible radial pull at connection bolt	2000 N
Diameter of connection bolt	50/60 mm
Length of connection bolt	100/130 mm
Earth connection	4 x M12
Weight approx.	241 kg
Silicone-Oil volume approx.	119 l
Packing information	2430 x 950 x 750 mm

DESIGN DATA	
Diameter over insulation	71 - 119 mm
Diameter over sheath	150 mm
Max. Cross section (Cu / Al)	Approx. 2500 mm ²
Creepage distance	5161 mm
Protected creepage distance [90°C shadow]	1840 mm
Flashover distance	2125 mm
Material of connection bolt	Aluminium / Copper
Material of insulator - outer surface	Silicone rubber
Profile of insulator	Regular sheds
Colour of insulator	Grey
Method of stress control	Geometric
Stress cone	Pre-fabricated silicone rubber
Max. permissible dielectric stress	4 kV/mm (at insulation screen of cable)
Insulating liquid	Silicone oil
Material of fittings	Aluminium
Clearance between terminations	As per IEC 60071-1
Installation temperature	0°C - +50°C
Operation temperature	-55°C - +55°C
Storage temperature	0°C - +40°C

ELECTRICAL TYPE TEST IEC 62067	
Heating cycle voltage	254 kV
Partial discharge at ambient and elevated temperatures	190 kV
Lightning impulse voltage 1.2µs/50µs	1050 kV
ELECTRICAL ROUTINE TEST IEC 62067	
AC withstand voltage	318 kV
Partial discharge test	190 kV

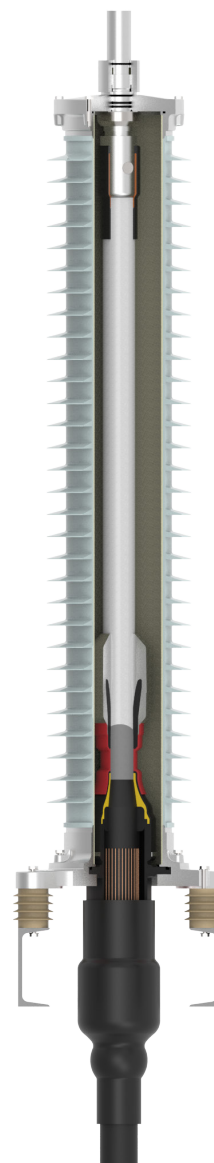

te.com/energy

© 2018 TE Connectivity. All Rights Reserved. EPP-3125-DDS-8/18-Termination-OHVT-245C-2A-TE

Raychem, TE Connectivity and TE connectivity (logo) are trademarks. Other logos, product and/or company names might be trademarks of their respective owners. While TE has made every reasonable effort to ensure the accuracy of the information in this brochure, TE does not guarantee that it is error-free, nor does TE make any other representation, warranty or guarantee that the information is accurate, correct, reliable or current. TE reserves the right to make any adjustments to the information contained herein at any time without notice. TE expressly disclaims all implied warranties regarding the information contained herein, including, but not limited to, any implied warranties of merchantability or fitness for a particular purpose. The dimensions in this catalog are for reference purposes only and are subject to change without notice. Specifications are subject to change without notice. Consult TE for the latest dimensions and design specifications.

FOR MORE INFORMATION: TE Technical Support Centers

USA:	+ 1 800 327 6996
Canada:	+ 1 (905) 475-6222
Mexico:	+ 52 (0) 55-1106-0800
Latin/S. America:	+ 54 (0) 11-4733-2200
France:	+ 33 380 583 200
UK:	+ 44 0870 870 7500
Germany:	+ 49 896 089 903
Spain:	+ 34 916 630 400
Italy:	+ 39 333 250 0915
Benelux:	+ 32 16 508 695
Russia:	+ 7 495-790 790 2-200
China:	+ 86 (0) 400-820-6015

While TE Connectivity (TE) has made every reasonable effort to ensure the accuracy of the information in the catalog, TE does not guarantee that it is error free, nor does TE make any other representation, warranty or implied warranties regarding the information contained herein, including, but not limited to, any implied warranties or merchantability or fitness for a particular purpose. The dimensions in this catalog are for reference purpose only and are subject to change without notice. Specifications are subject to change without notice. Consult TE for the latest dimensions and design specifications.

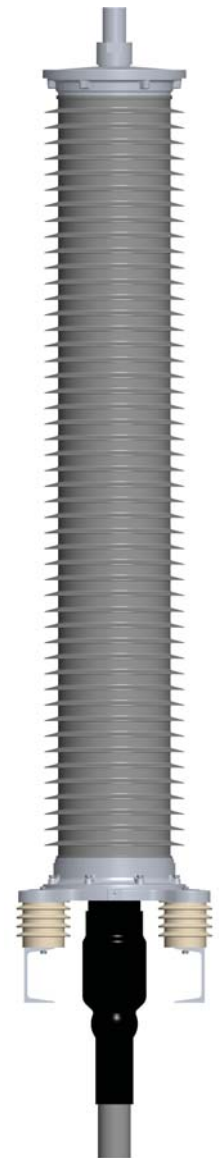
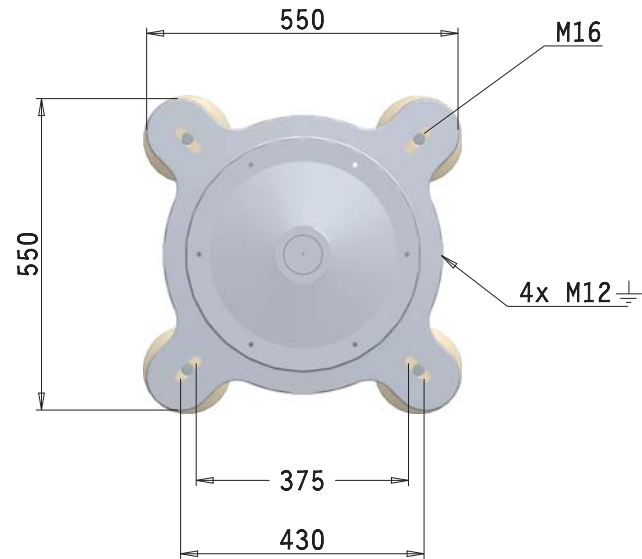
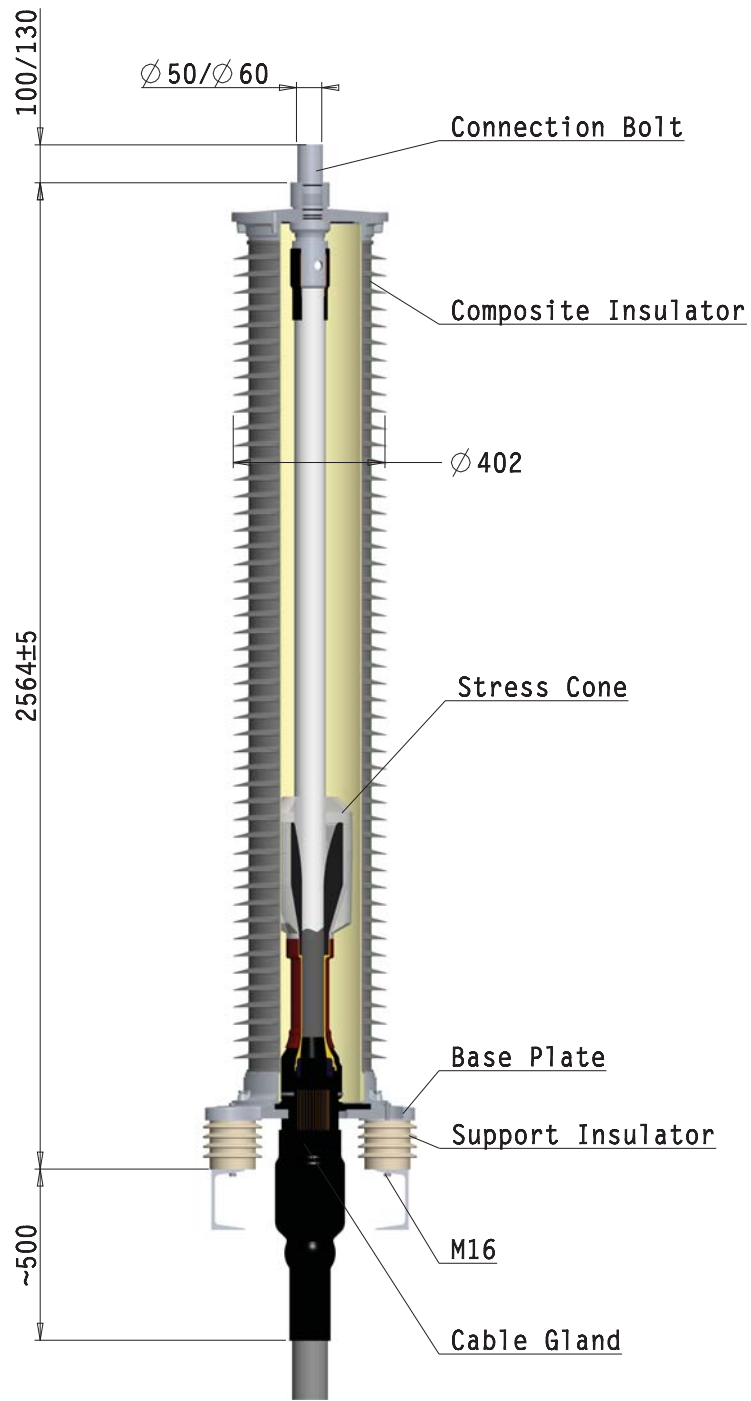

OUTDOOR-TERMINATION
245 kV
COMPOSITE-INSULATOR
FOR POLYMERIC-CABLE

OHVT-245C (-2A)
Offer drawing



Raychem High Voltage Cable Accessories

TE Connectivity drawing no: EPD-204-1431-00 REV. 1